



Line 3 Bus Replacement Service

**Derailment Incident Overview and
Operational Improvements for Bus Replacement
Service**

September 26, 2023

Overview - Derailment Incident and Operational Improvements for Bus Replacement Service

1. History and Background
2. Incident Investigation
3. Upcoming Service Improvements



| Line 3 History

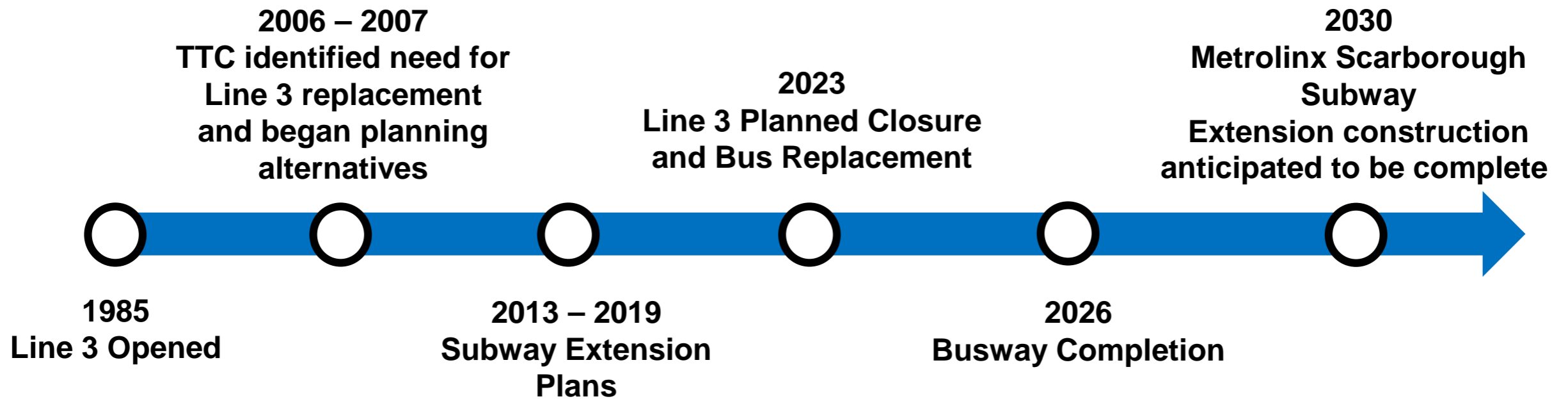

Bus Replacement Plan

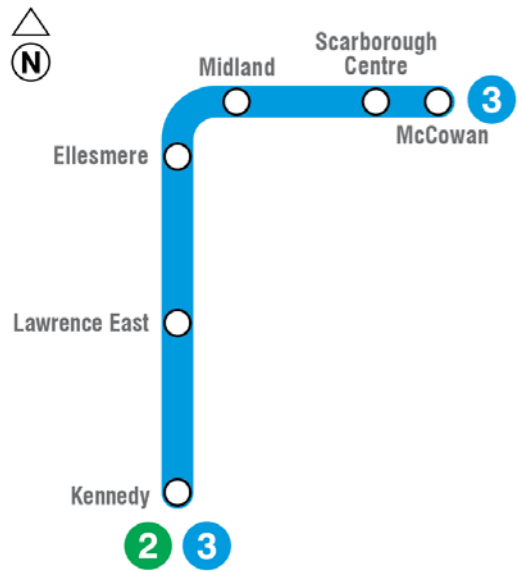

Line 3 Train Service



Emergency Shuttle
July 24-August 25



Temporary Bus Lanes
August 26-November 18



Full Transit Priority Measures
Starting November 19

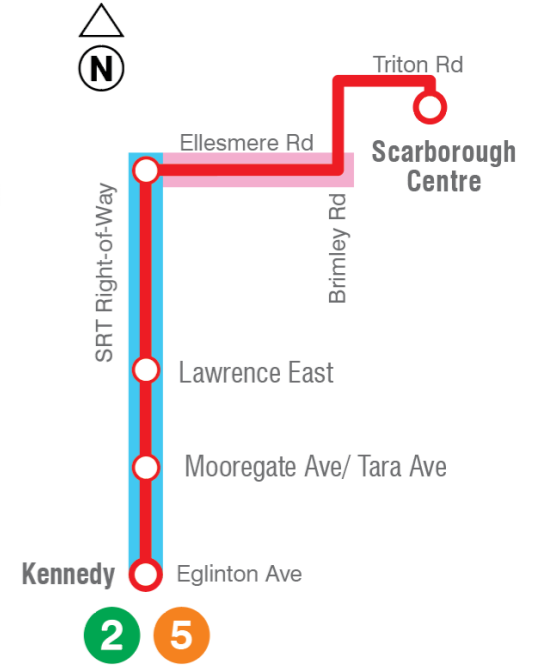

Future Busway



Public Consultations

- Since 2021, multiple rounds of public engagement helped to develop the bus replacement plan
- During main consultation period, over 18 weeks with 20 events that 1,200 people participated in
- Transit customers, local residents, BIAs, and other stakeholders participated in stakeholder meetings, Community Coordination Tables, focus groups, public surveys, and pop-up meetings
- TTC continues to consult with stakeholders throughout this project



Accelerating the Line 3 Bus Replacement Plan

- **Line 3 Closure** - originally scheduled for November 19
- **Derailment incident** - on July 24 prompted shutdown of the line
- **Accelerating Transit Priority Measures** - working with the City to accelerate the implementation of transit priority measures

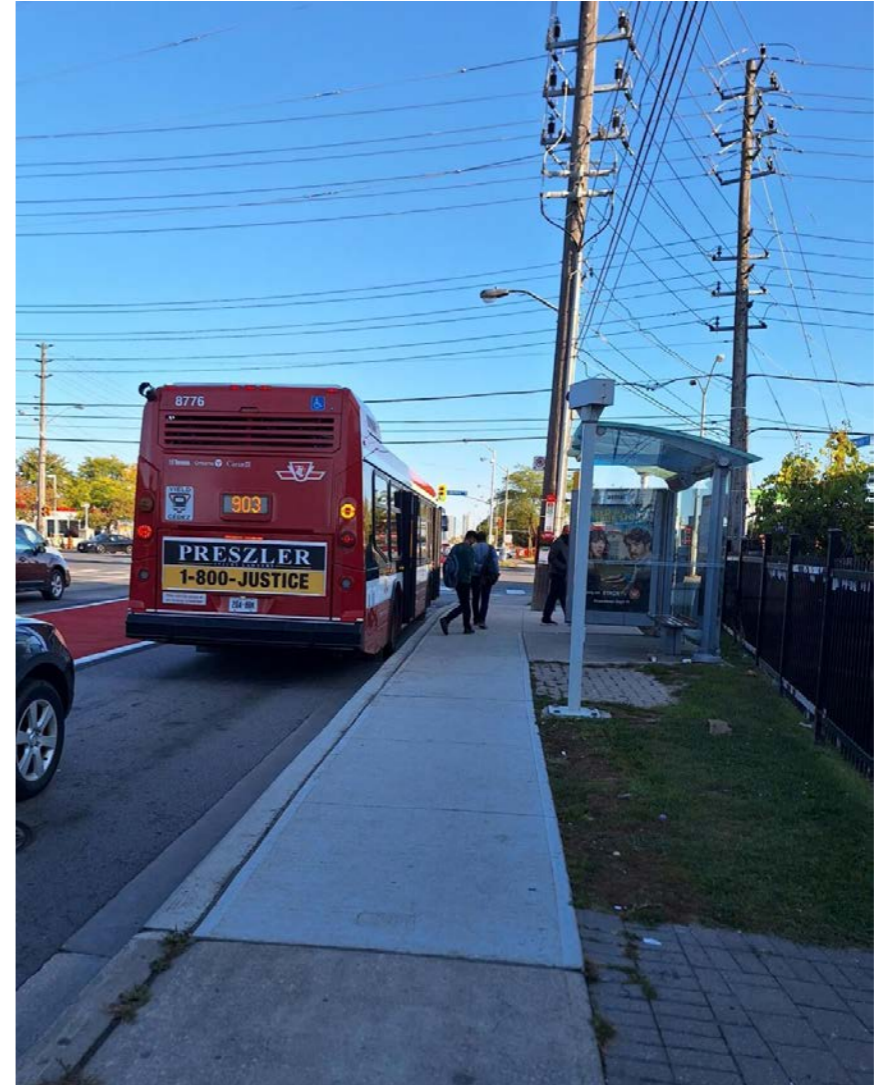

Replacement bus on Kennedy at Lawrence

July 24 – August 25: Emergency Response

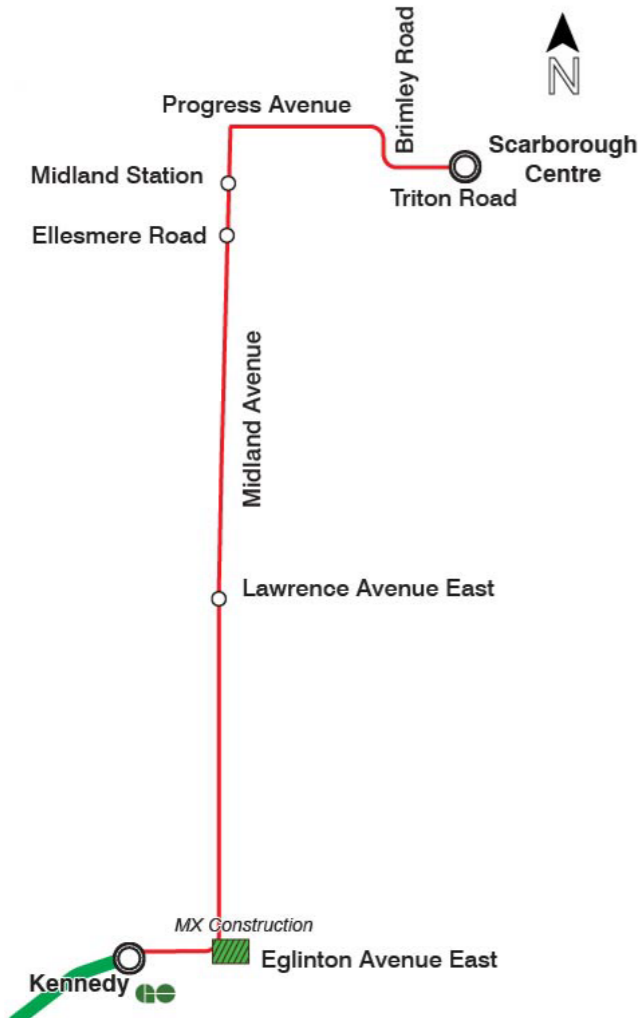

Shuttle bus routing



New bus layover area at Kennedy Station to reduce congestion



New traffic control measures to improve bus flow at Kennedy Station



Starting August 26: Temporary Bus Priority Lanes

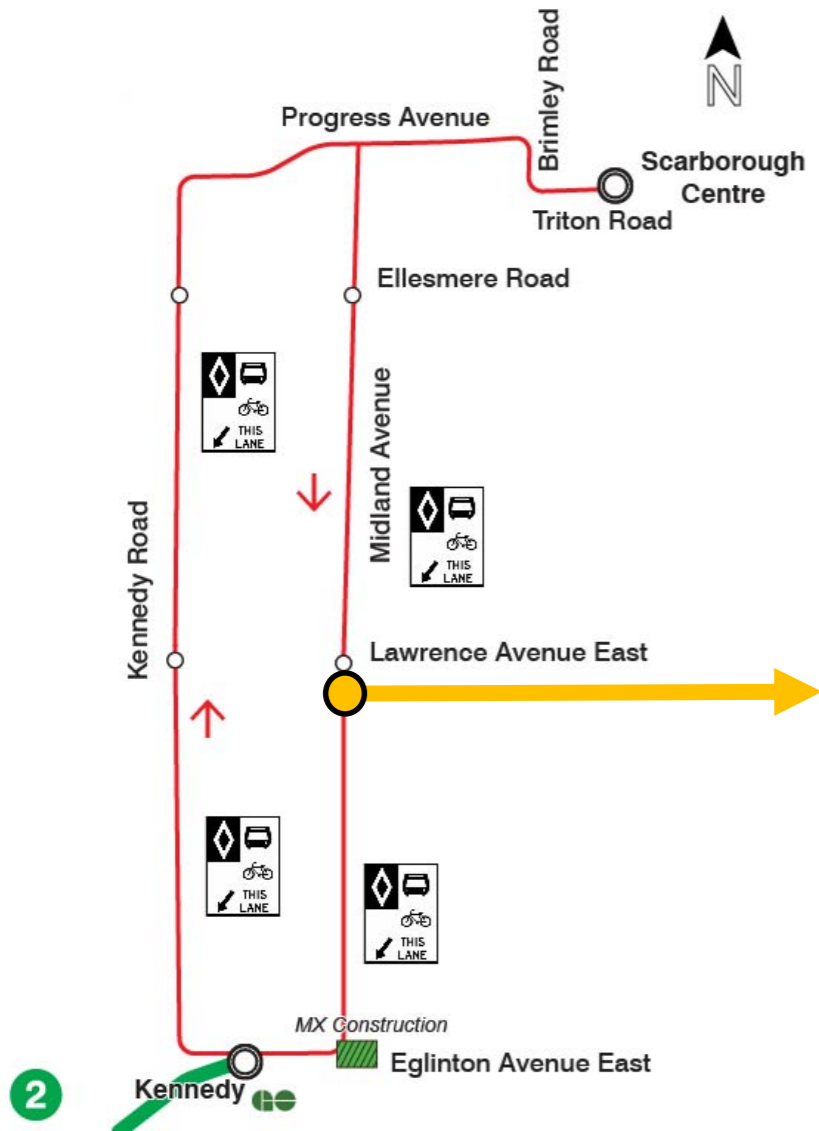

Temporary Bus Priority Lanes

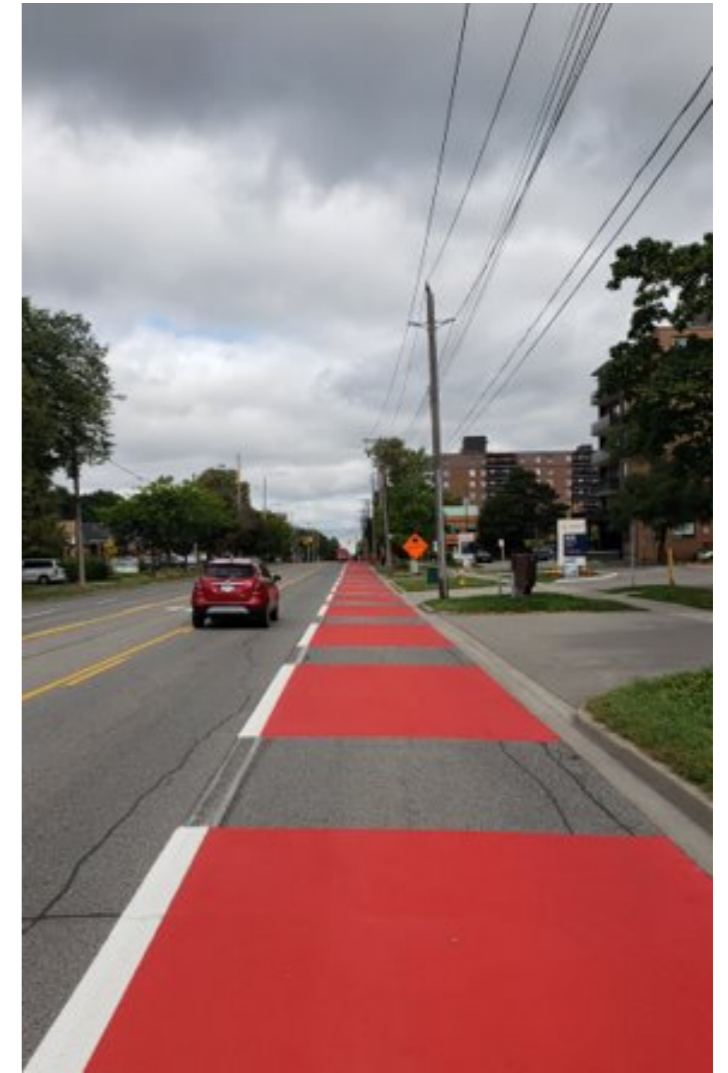

RapidTO Style Bus Priority Lanes



Since September 3: Improvements to Shuttles



903 Bus Platform at Scarborough Centre

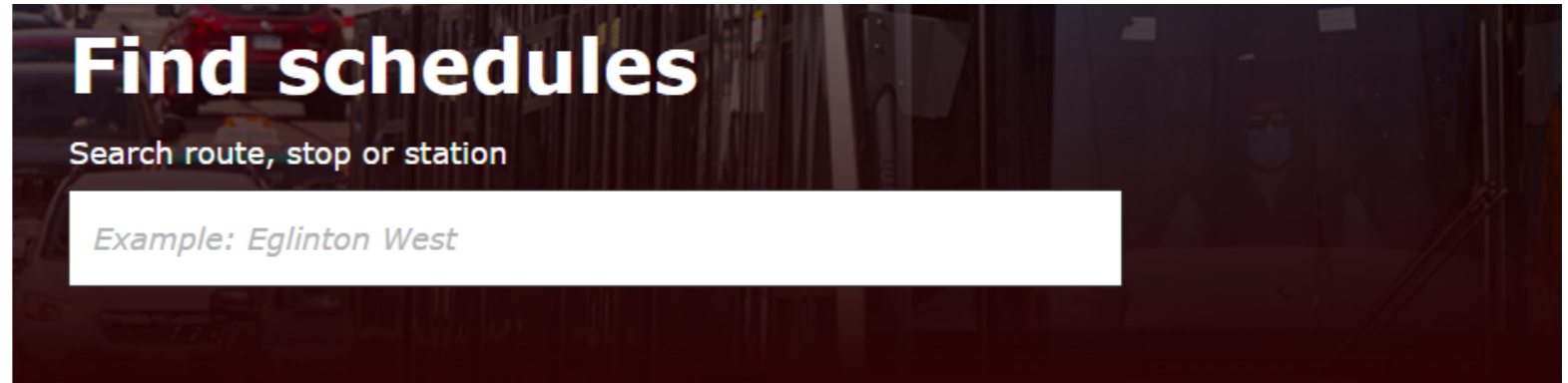

Stop Number: 5713 

Midland Ave at Lawrence Ave East

903 Kennedy-Scarborough Centre Express

Direction: **Southbound**



Due



3 min



4 min

 Did you know?

You can use the Stop Number to help plan your trip or find out when the next bus will arrive by texting the Stop Number to 898882.



Derailment Investigation



Line 3 Rail System Overview

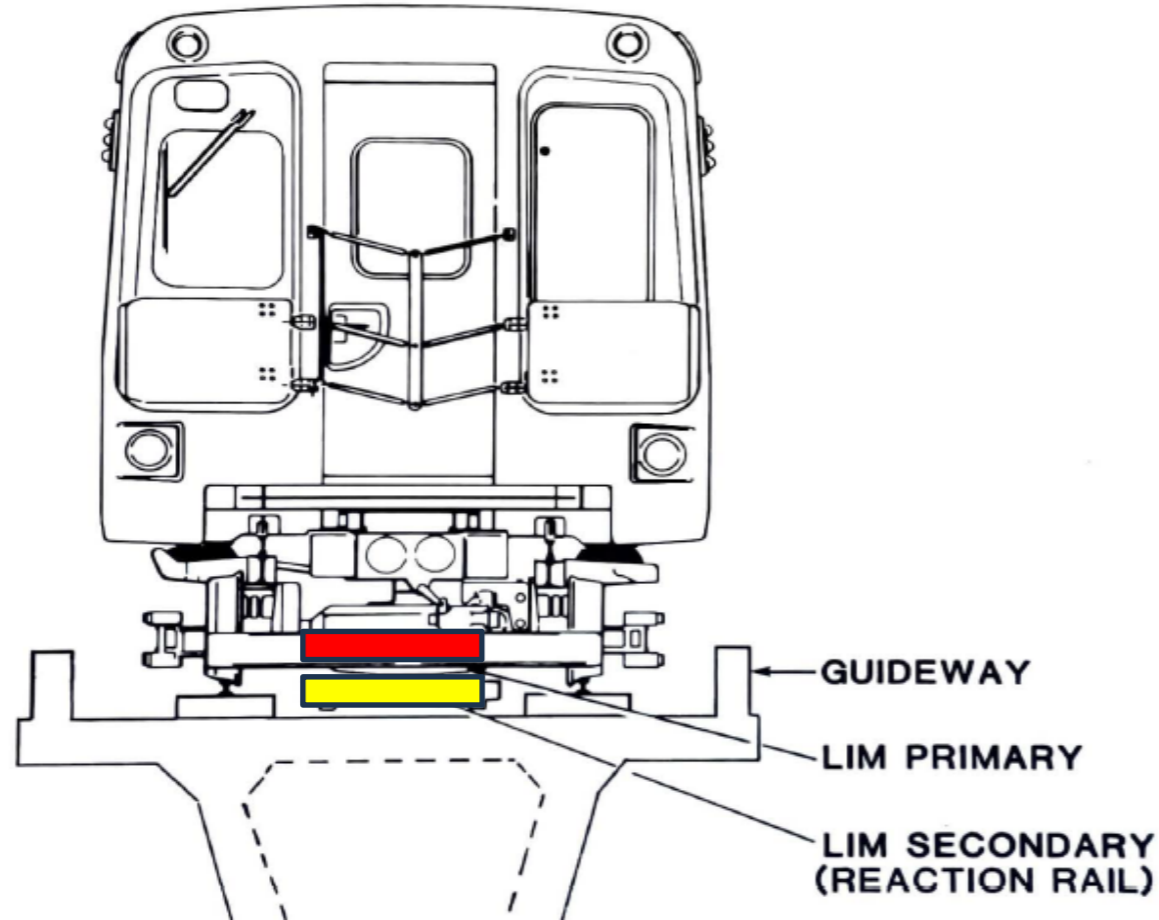

SRT Topology

- The SRT system utilizes a unique propulsion design – known as Linear Motor Propulsion.
- SRT is propelled by a short stator (LIM primary) and a long rotor (Reaction Rail).

Incident Background

Lawrence East Station

Direction of Travel - Southbound

Ellesmere Station



First Train - Passed derailment site at 6:37pm



Second Train - Passed derailment site at 6:43pm



Initial Investigation



SRT Rail System

Investigation Findings

- Running rails – within standard, and not a contributing factor.
- Vehicle – No concerns with the vehicle dynamic, and its interaction with the running rails.
- Reaction Rail – anchor bolts became the focus of the root cause analysis.

Root Cause Analysis – Reaction Rail Anchor Bolts

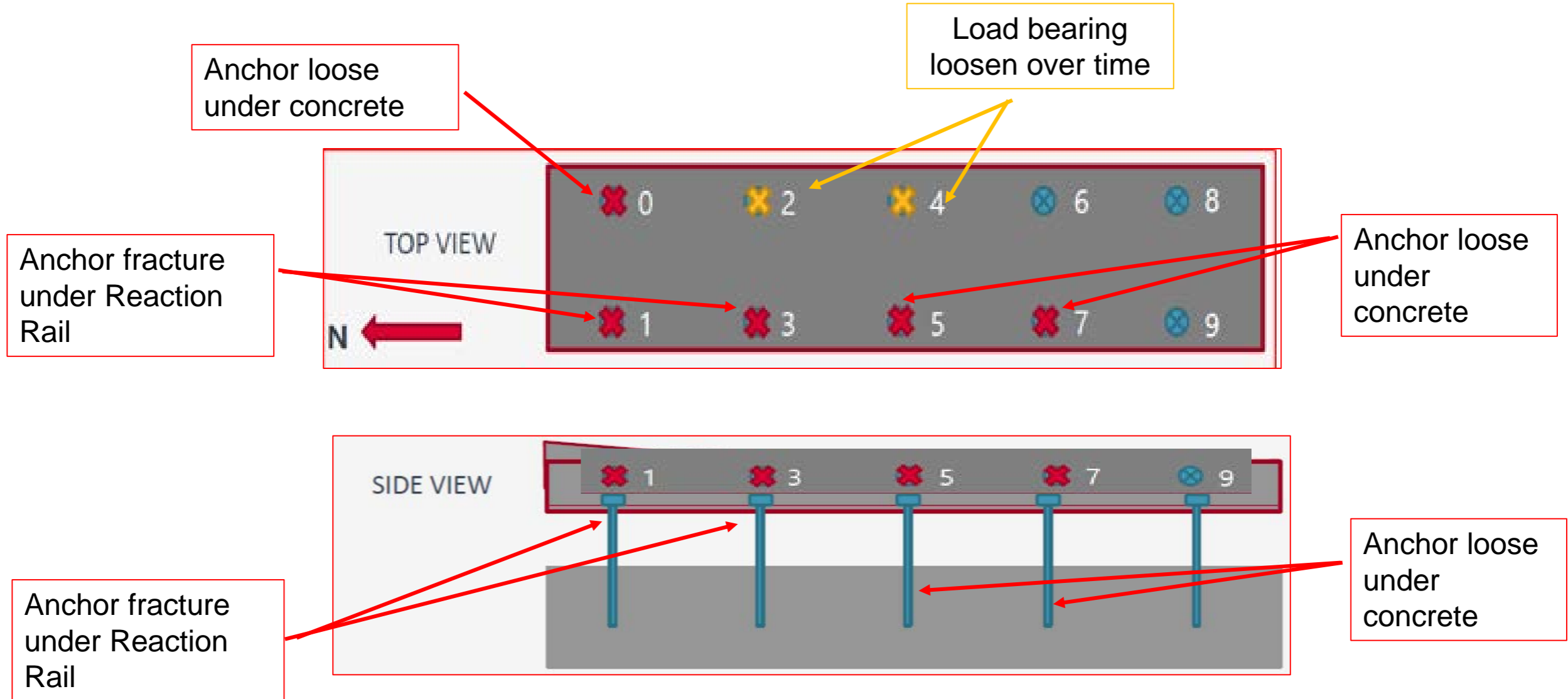

| Dynamic Simulation

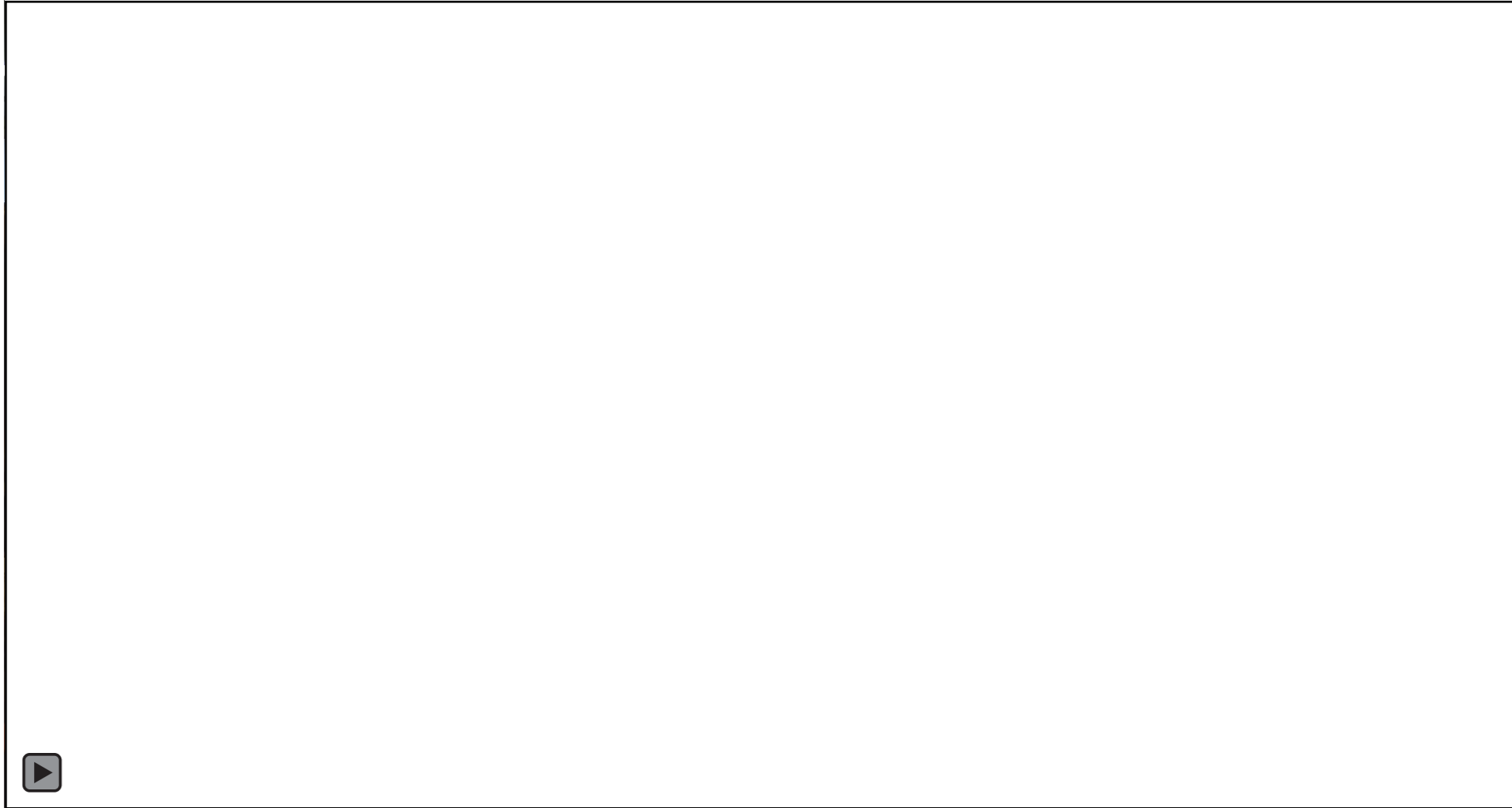

Reaction Rail Anchor 0, 1, 2 and 3 Loose

Summary of Investigation and Next Steps

Investigation Findings

- No concerns with running rails conditions and vehicle conditions
- The immediate cause of the derailment is failed reaction rail anchor bolts

Deliberations

- The reaction rail system is not used anywhere else in the TTC rail systems
- The reaction rail system is only used in two other North American transit systems, Vancouver and Detroit

Next Steps

- Permanently close the SRT
- Continue planned maintenance improvements
- Safety team and third-party review to validate findings



By November 19 – Transit Priority Measures Complete

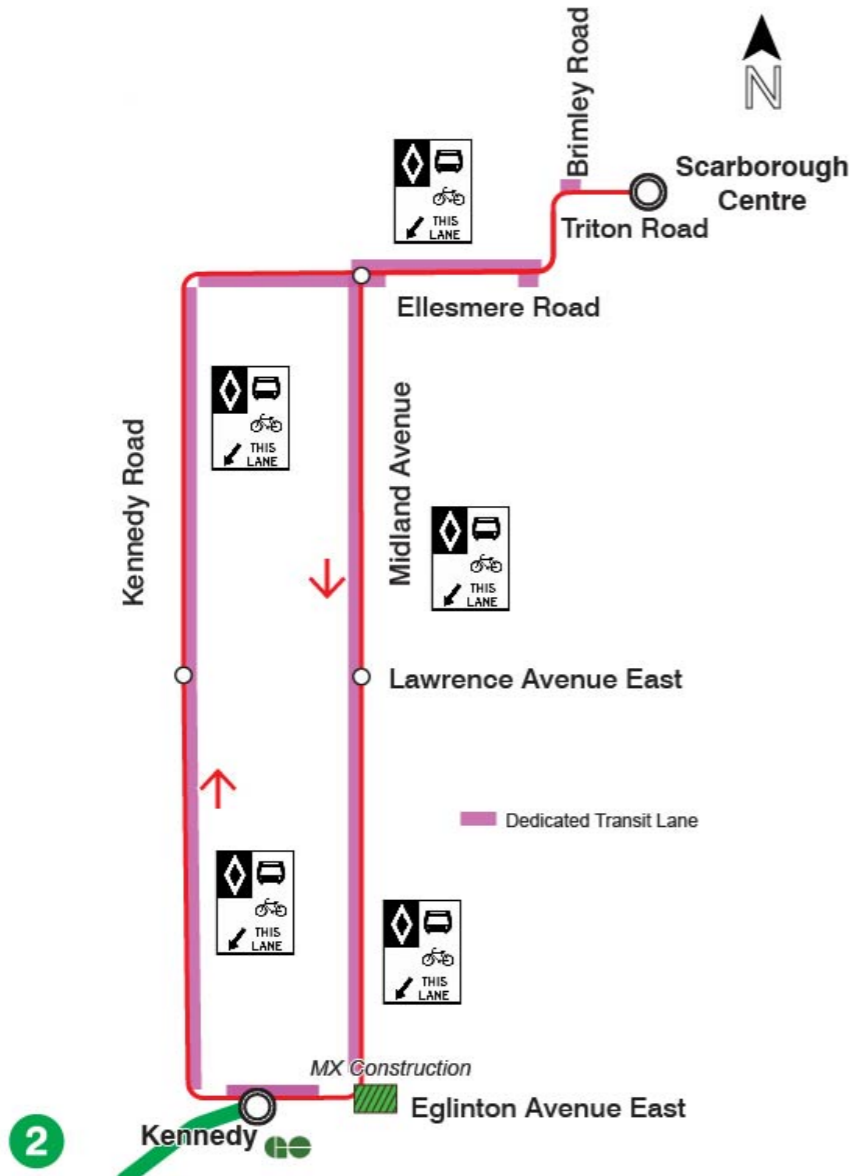

- By October new south lot bus terminal will open at Kennedy Station
- Transit priority measures progressing well - Kennedy and Ellesmere fully implemented, and Midland will be complete by early November
- Bus network improvements will also be implemented

Service Plan – Effective November 19, 2023

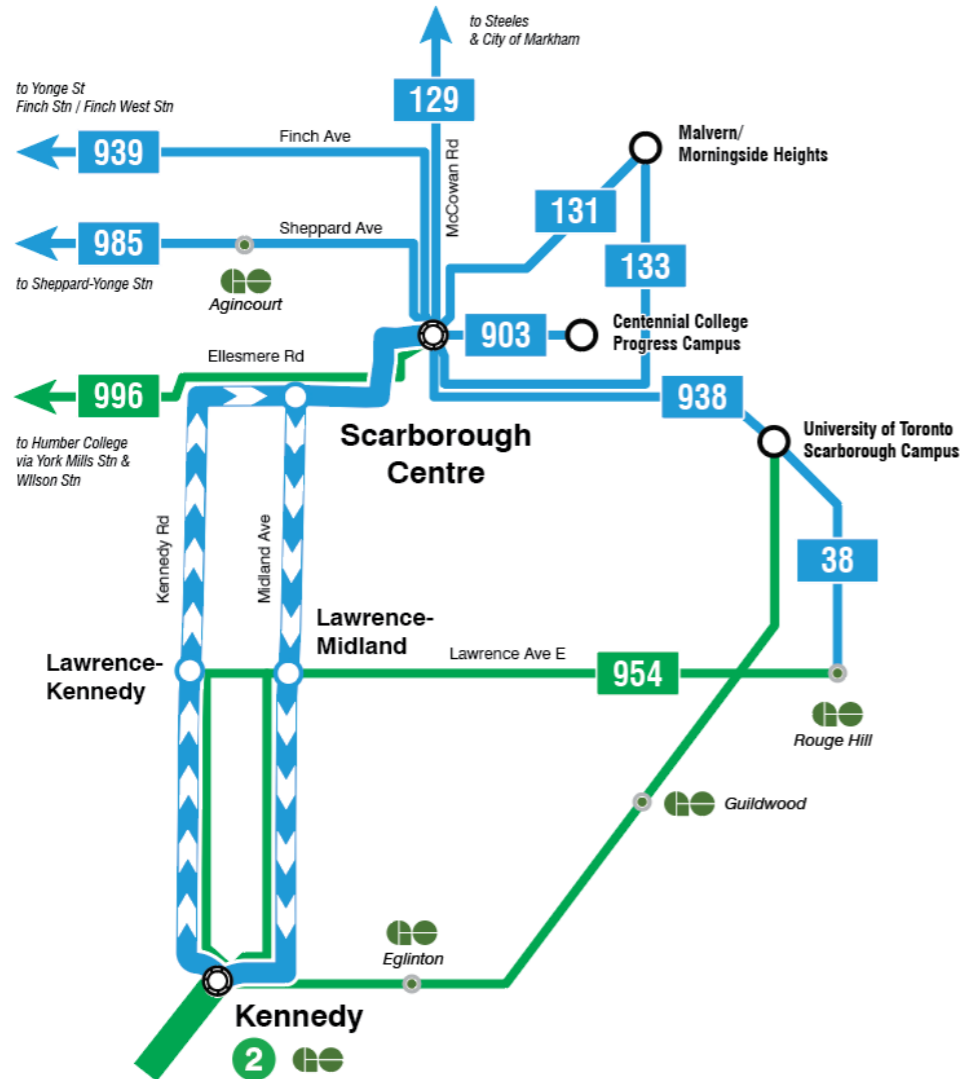

Improvements to the customer journey by extending 8 routes to Kennedy Station

Better connections with direct access from Kennedy Station to major destinations like Centennial College

Eliminate transfers by providing 80% of customers a through trip – saving time and hassle of switching buses

Monitoring and adjusting the network

- We will monitor ridership and customer feedback and adjust service in 2024, including impacts on other bus routes in Scarborough.
- We will explore opportunities to strengthen GO Transit connections to leverage fare integration in early 2024.

How will a journey from Malvern to Kennedy change?

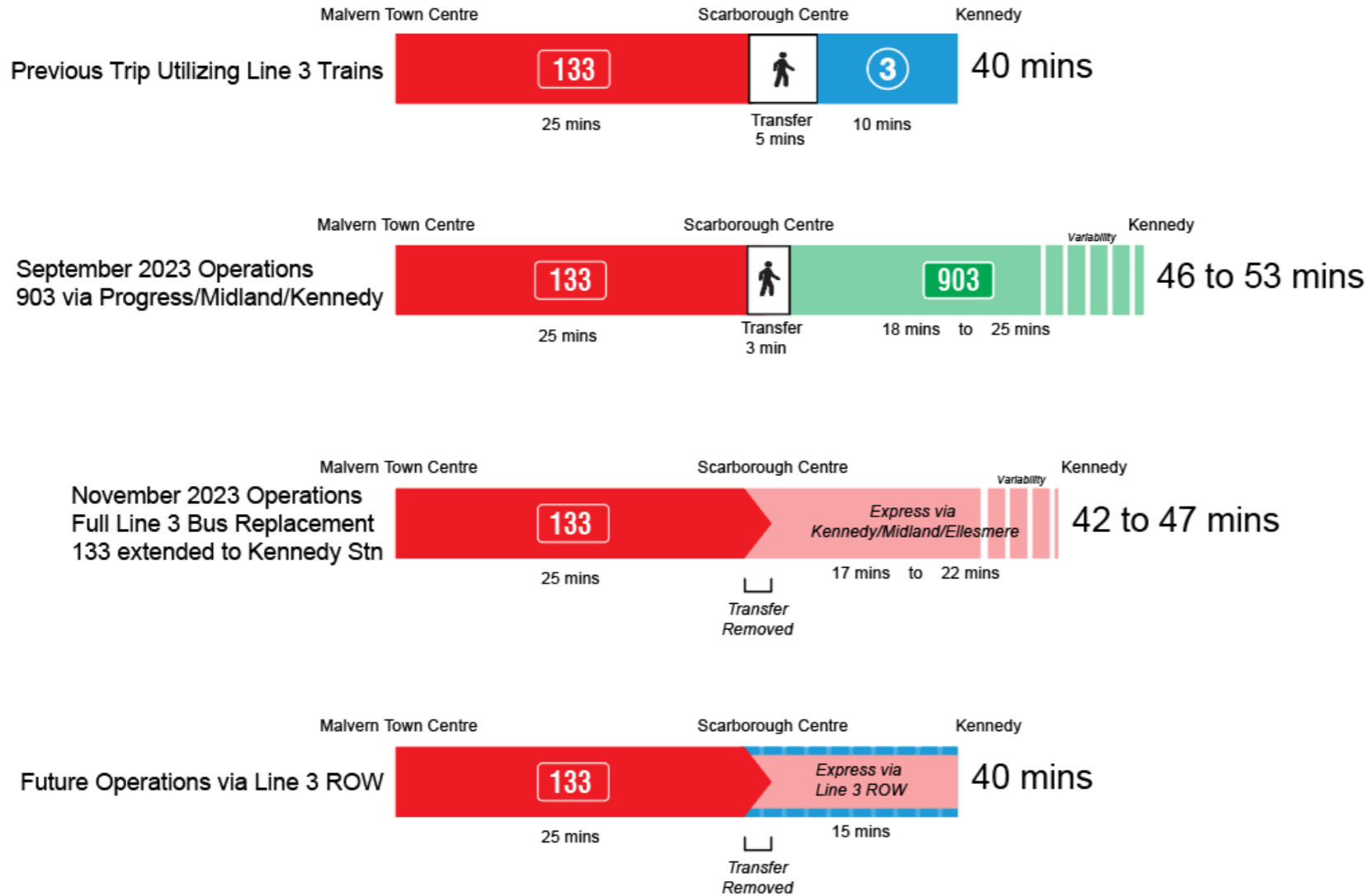

While trains provided faster trip, multiple transfers and train reliability were pain points

Since Line 3 closed, 903 express provides frequent service but still requires a transfer. Expedited bus lanes are improving predictability of travel

In November, transfers will be eliminated for many trips. Travel will become more predictable with full implementation of transit priority measures.

With a busway on the Line 3 ROW, buses will avoid over 15 signalized intersections and potential conflicts at driveways to provide a faster and even more predictable trip.



Busway Update

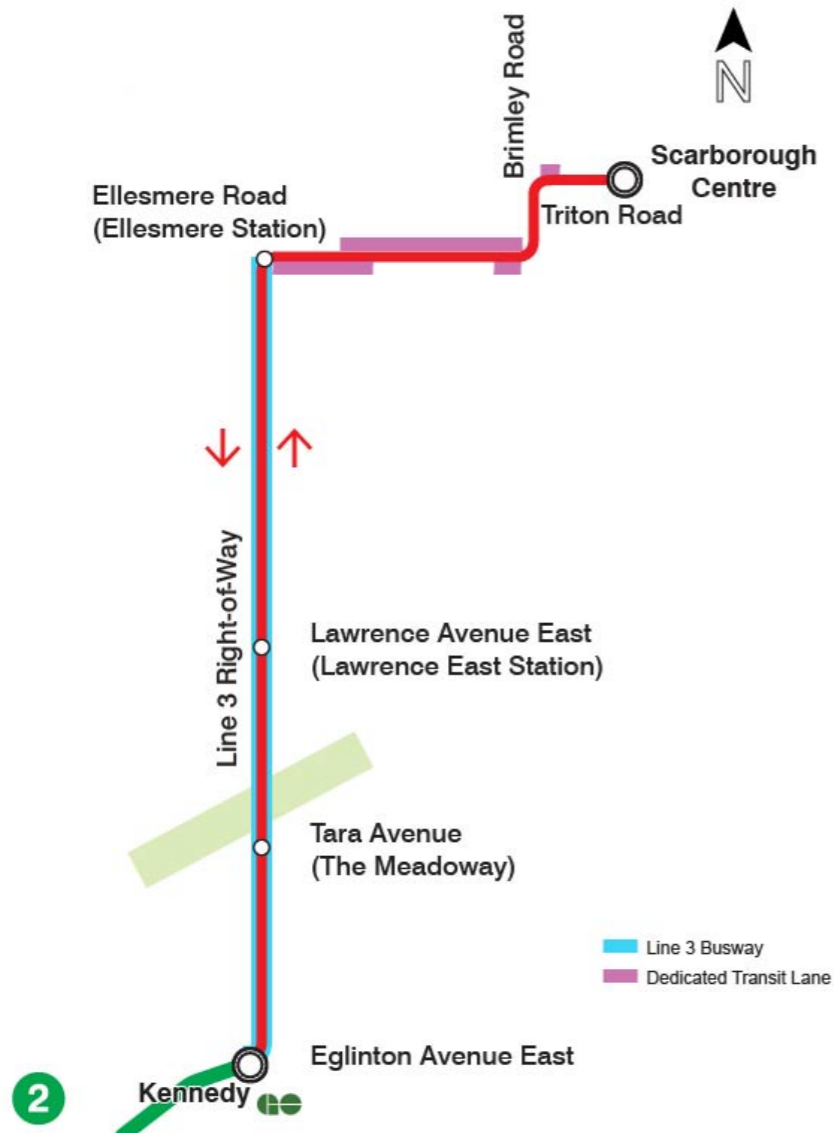

- TTC is progressing to final design on the Busway
- As part of this work, customers and local stakeholders will be re-engaged in the weeks ahead
- The City continues to explore alternative uses for the elevated guideway
- Report to TTC Board will follow in Q4 2023



